

IPCA Medium-pressure internal gear pumps Technical data sheet

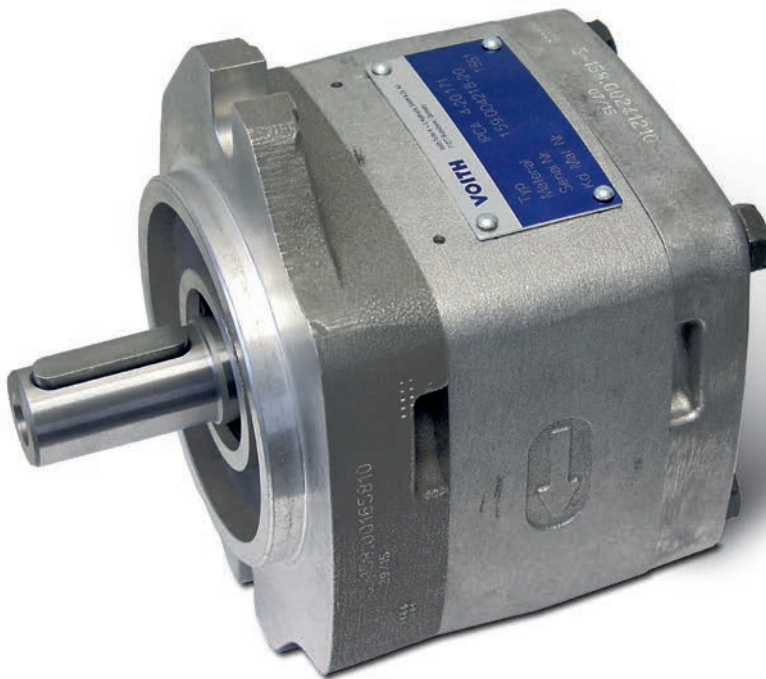

Advantages

- + High volumetric and overall efficiency
- + Very good pulsation behavior
- + Robust and compact
- + Low noise emission
- + Multiple flow capable

Design and function

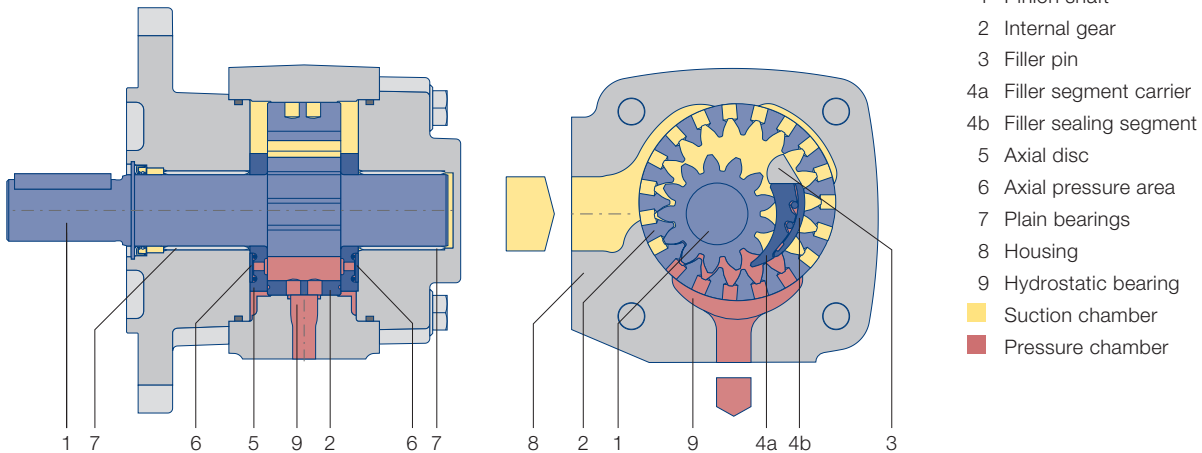

Function

By rotation of the gears inside the pump, the pressure fluid (usually hydraulic oil) is drawn into the cavity between the pinion and internal gear. Optimized cross-sectional areas on suction side as well as on pressure side allow operation over a wide range of speed.

In the radial direction, the gear chambers are closed by gear meshing and the filler piece. In the axial direction, the axial plates seal the pressure chamber with the minimal possible gap. This design minimizes volume losses and increases efficiency.

Calculations

Pump flow $Q = V_{g\text{th}} \cdot n \cdot \eta_v \cdot 10^{-3} \text{ [l/min]}$

Power $P = \frac{Q \cdot \Delta p}{600 \cdot \eta_g} \text{ [kW]}$

$V_{g\text{th}}$ pump volume per revolution [cm³]

n Speed [rpm]

η_v Volumetric efficiency

η_g Overall efficiency

Δp Differential pressure [bar]

Technical data

Design	Internal gear pump with radial and axial sealing gap compensation
Type	IPCA
Mounting types	SAE hole flange; ISO 3019/1
Line mounting	SAE suction and pressure flange J 518 C Code 61
Sense of rotation	right-hand rotation
Mounting position	any
Shaft load	for details of radial and axial drive shaft loads please contact J.M. Voith SE & Co. KG
Input pressure	0.8...3 bar absolute pressure (at start up for short time 0.6 bar)
Preload pressure. pressure port (in reversing mode)	for details please contact J.M. Voith SE & Co. KG
Pressure fluid	HLP mineral oils DIN 51524. part 2 or 3
Viscosity range	10 ... 300 mm ² s ⁻¹ (cSt)
Permissible start viscosity	max. 2 000 mm ² s ⁻¹ (cSt)
Permissible temperature of the pressure fluid	-20 ... +80 °C
Required purity of the pressure fluid	Class 20/18/15 (ISO 4406). Class 9 (NAS 1638)
Filtration	filtration quotient min. $\beta_{20} \geq 75$. recommended $\beta_{10} \geq 100$ (longer life)
Permissible ambient temperature	-20 ... +60 °C

Characteristics

Type. size – delivery	Displacement per revolution [cm ³]	Speed min. [rpm]	Speed max. [rpm]	Delivery at 1 500 rpm [l/min]	Continuous pressure [bar]	Peak pressure at 1 500 rpm [bar]	Moment of inertia [kg cm ²]
IPCA 3 – 3.5	3.6	400	3 600	5.4	210	250	0.34
IPCA 3 – 5	5.2	400	3 600	7.8	210	250	0.42
IPCA 3 – 6.3	6.4	400	3 600	9.6	210	250	0.49
IPCA 3 – 8	8.2	400	3 600	12.3	210	250	0.58
IPCA 3 – 10	10.2	400	3 600	15.3	210	250	0.70
IPCA 4 – 13	13.3	400	3 600	19.9	210	250	2.25
IPCA 4 – 16	15.8	400	3 400	23.7	210	250	2.64
IPCA 4 – 20	20.7	400	3 200	31.0	210	250	3.29
IPCA 4 – 25	25.4	400	3 000	38.1	210	250	3.70
IPCA 4 – 32	32.6	400	2 800	48.9	210	250	4.44
IPCA 5 – 40	41.0	400	2 800	61.5	210	250	10.20
IPCA 5 – 50	50.3	400	2 600	75.4	210	250	11.60
IPCA 5 – 64	64.9	400	2 600	97.3	210	250	14.40

The values given apply for

- Pumping of mineral oils with a viscosity of 20 ... 40 mm²s⁻¹
- An input pressure of 0.8...3.0 bar absolute

Notes

- Peak pressures apply for 15 % of operating time with a maximum cycle time of 1 minute
- Please inquire about peak pressures at non-standard speeds
- Due to production tolerances, the pump volume may be reduced by up to 1.5 %.

IPCA Size 3, Rotation and dimensions

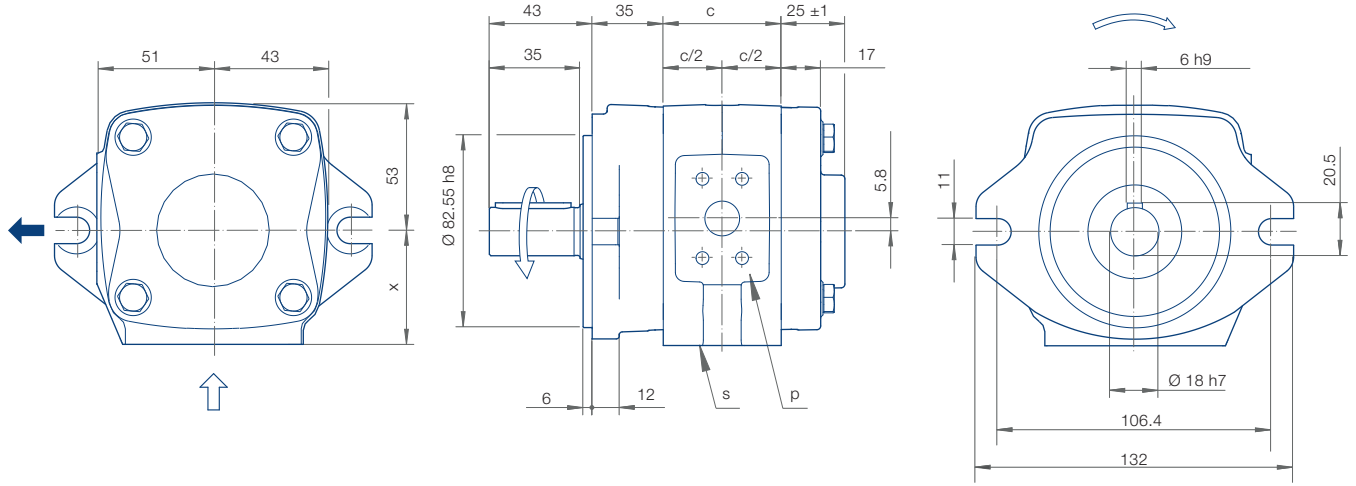

Pressure port (P)

Suction port (S)

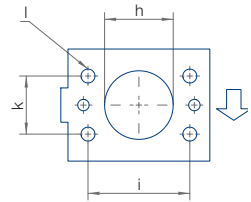
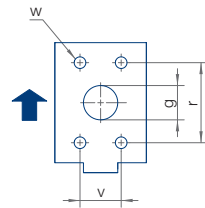

Type/ Delivery	c [mm]	x [mm]	g [mm]	h [mm]	i [mm]	k [mm]	l Thread	r [mm]	v [mm]	w Thread	Weight [kg]	SAE Flange No. ↑ ↓
IPCA 3 – 3.5	66	47.2	9	15	38.1	17.5	M8x13	38.1	17.5	M8x15	2.6	10 10
IPCA 3 – 5	70	47.2	11	15	38.1	17.5	M8x13	38.1	17.5	M8x15	2.8	10 10
IPCA 3 – 6.3	73	50.2	11	20	47.6	22.3	M10x15	38.1	17.5	M8x15	2.9	10 11
IPCA 3 – 8	77.5	50.2	13	25	52.4	26.2	M10x15	38.1	17.5	M8x15	3.0	10 12
IPCA 3 – 10	82.5	51.5	13	25	52.4	26.2	M10x15	38.1	17.5	M8x15	3.1	10 12

* Ensure the M10x1 plug screw, hexagon socket SW5, is tightened to a torque of 10 Nm during pumping operation. Dependent on the pump position, filling or ventilation is possible here prior to commissioning.

IPCA Size 3, Designs

Rotation, Suction port

Mounting flange

Shaft end

Standard

Rotation clockwise

SAE 2-hole flange

Keyway connection

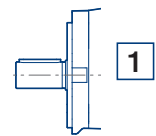
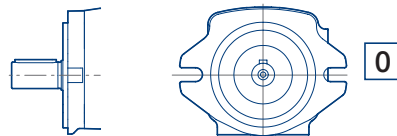

IPCA Size 4, Rotation and dimensions

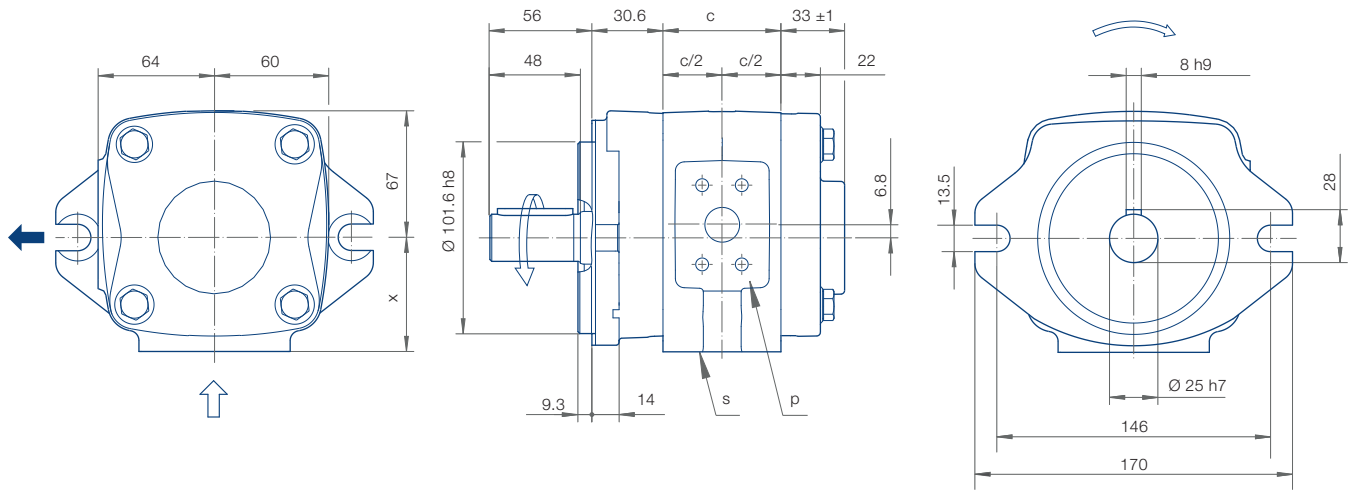

Pressure port (P)

Suction port (S)

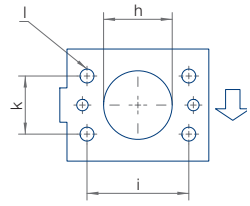
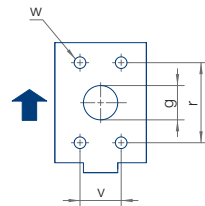

Type/ Delivery	c [mm]	x [mm]	g [mm]	h [mm]	i [mm]	k [mm]	l Thread	r [mm]	v [mm]	w Thread	Weight [kg]	SAE Flange No.
IPCA 4 – 13	48.5	57.2	14	25	52.4	26.2	M10x15	38.1	17.5	M8x15	5.5	10
IPCA 4 – 16	52.5	57.2	18	30	58.7	30.2	M10x15	47.6	22.3	M10x15	5.7	11
IPCA 4 – 20	58	57.2	18	30	58.7	30.2	M10x15	47.6	22.3	M10x15	6.0	11
IPCA 4 – 25	64	63.2	18	40	69.9	35.7	M12x20	47.6	22.3	M10x15	6.2	11
IPCA 4 – 32	73	63.2	18	40	69.9	35.7	M12x20	47.6	22.3	M10x15	6.7	11

* Ensure the M10x1 plug screw, hexagon socket SW5, is tightened to a torque of 10 Nm during pumping operation.
 Dependent on the pump position, filling or ventilation is possible here prior to commissioning.

IPCA Size 4, Designs

Rotation, Suction port

Mounting flange

Shaft end

Standard

Rotation clockwise

SAE 2-hole flange

Keyway connection

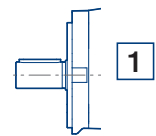
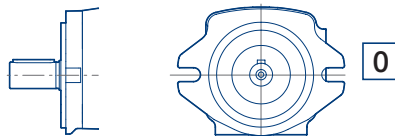

IPCA Size 5, Rotation and dimensions

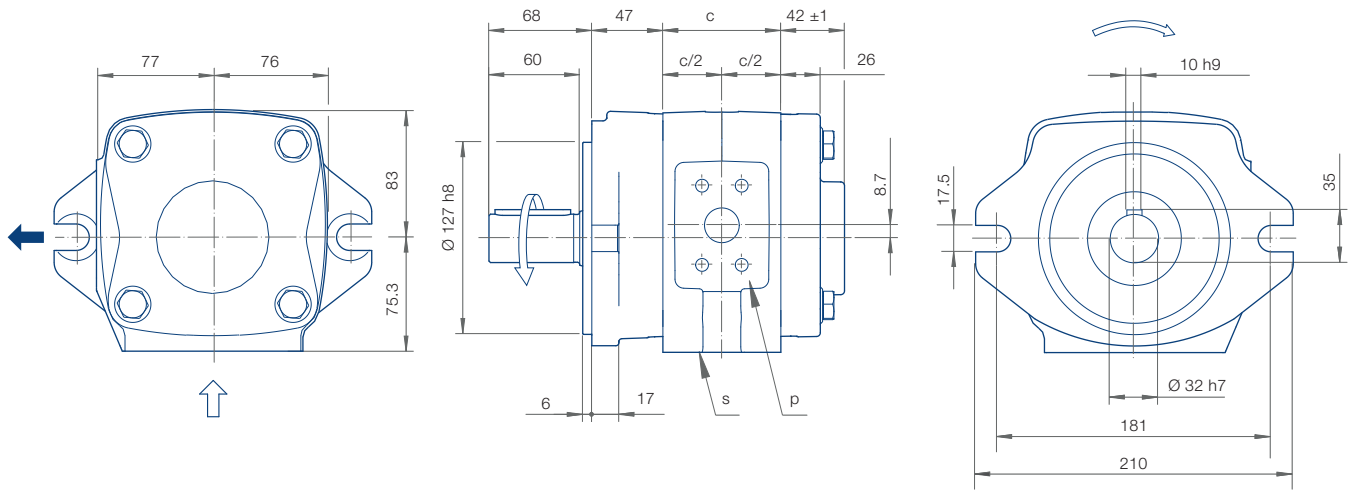

Pressure port (P)

Suction port (S)

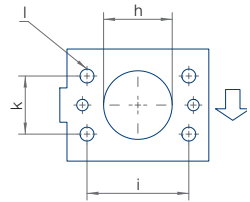
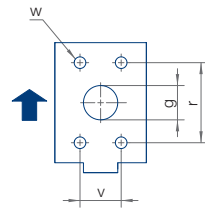

Type/ Delivery	c [mm]	g [mm]	h [mm]	i [mm]	k [mm]	l Thread	r [mm]	v [mm]	w Thread	Weight [kg]	SAE Flange No. ↑ ↓
IPCA 5 – 40	71	19	40	69.9	35.7	M12x20	52.4	26.2	M10x15	11.6	12 30
IPCA 5 – 50	78	23	45	77.8	42.9	M12x20	52.4	26.2	M10x15	12.2	12 15
IPCA 5 – 64	89	23	45	77.8	42.9	M12x20	52.4	26.2	M10x15	13.1	12 15

* Ensure the M10x1 plug screw, hexagon socket SW5, is tightened to a torque of 10 Nm during pumping operation.
 Dependent on the pump position, filling or ventilation is possible here prior to commissioning.

IPCA Size 5, Designs

Rotation, Suction port

Mounting flange

Shaft end

Standard

Rotation clockwise

SAE 2-hole flange

Keyway connection

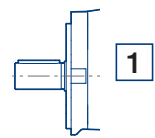
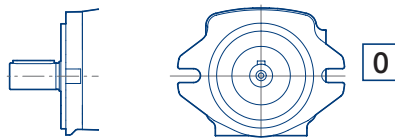

Airborne noise level (measuring location 1 m axial)

IPCA 3

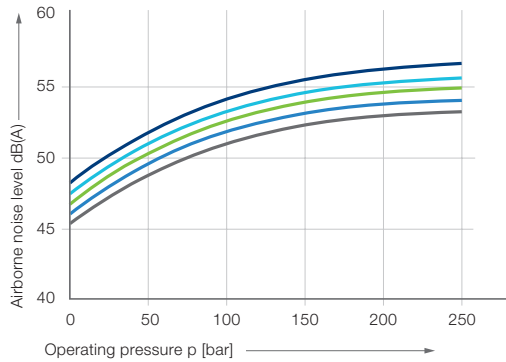

— IPCA 3 – 10 — IPCA 3 – 8 — IPCA 3 – 6.3
— IPCA 3 – 5 — IPCA 3 – 3.5

IPCA 4

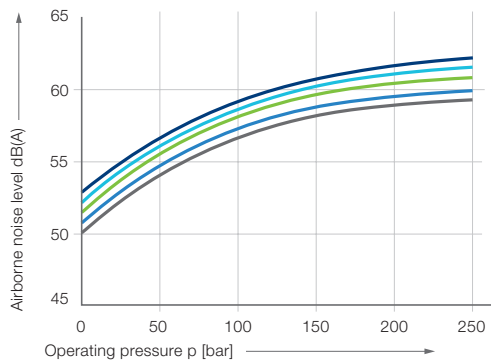

— IPCA 4 – 32 — IPCA 4 – 25 — IPCA 4 – 20
— IPCA 4 – 16 — IPCA 4 – 13

IPCA 5

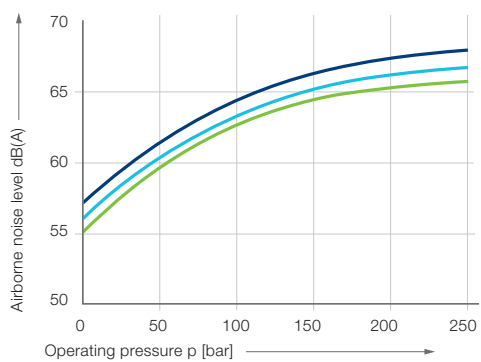

— IPCA 5 – 64 — IPCA 5 – 50 — IPCA 5 – 40

Measurement conditions

- Speed: 1 500 rpm
- Viscosity of pressure fluid: 46 mm²s⁻¹
- Operating temperature: 40 °C

Efficiency η_v and η_g

IPCA 3

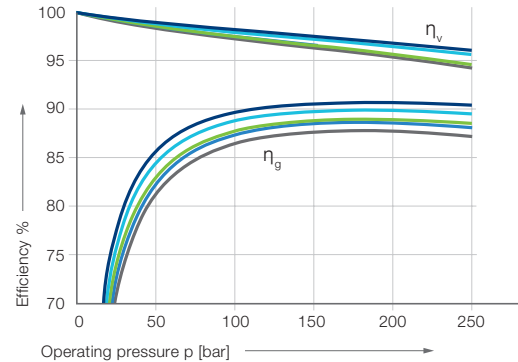

— IPCA 3 – 10 — IPCA 3 – 8 — IPCA 3 – 6.3
— IPCA 3 – 5 — IPCA 3 – 3.5

IPCA 4

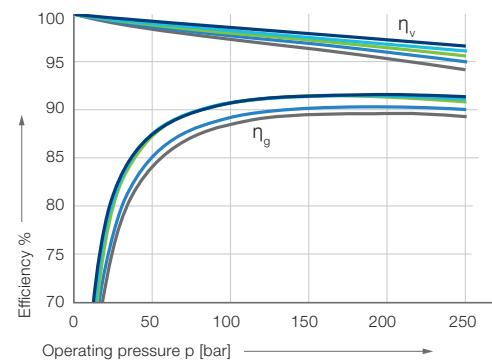

— IPCA 4 – 32 — IPCA 4 – 25 — IPCA 4 – 20
— IPCA 4 – 16 — IPCA 4 – 13

IPCA 5

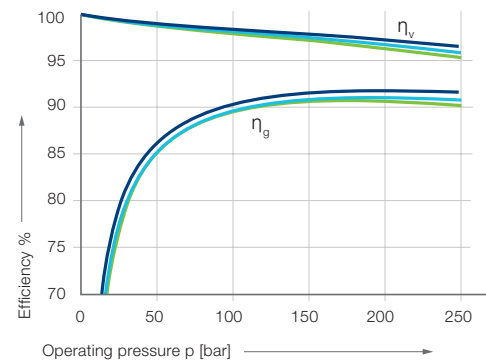

— IPCA 5 – 64 — IPCA 5 – 50 — IPCA 5 – 40

Note

Measurement taken in a low-noise room. In a anechoic room the measurements are approx. 5 dB(A) lower.

Suction and pressure flange according to SAE...

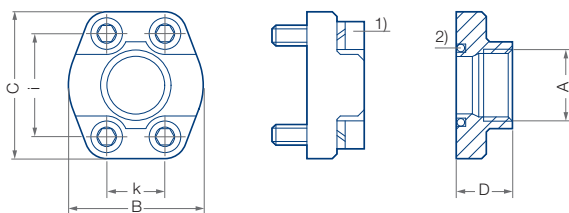

Wrench torque for screws according to ISO 6162

1) Screw EN ISO 4762

2) Round seal ring (O-Ring) ISO-R 1629 NBR

3) Special design. Deviation from SAE J 518 C Code 61

SAE flange no.	A Thread	B [mm]	C [mm]	D [mm]	E ¹⁾ Seal ring	i [mm]	k [mm]	S ²⁾ Thread	Max. pressure [bar]	
SAE J 518 C Code 61	10	G ½	46	54	36	18.66 – 3.53	38.1	17.5	M8	345
	11	G ¾	50	65	36	24.99 – 3.53	47.6	22.3	M10	345
	12	G 1	55	70	38	32.92 – 3.53	52.4	26.2	M10	345
	13	G 1-¼	68	79	41	37.69 – 3.53	58.7	30.2	M10	276
	14 ³⁾	G 1-½	82	98	50	47.22 – 3.53	69.9	35.7	M12	345 ³⁾
	30	G 1-½	78	93	45	47.22 – 3.53	69.9	35.7	M12	207
	15	G 2	90	102	45	56.74 – 3.53	77.8	42.9	M12	207
	16	G 2-½	105	114	50	69.44 – 3.53	88.9	50.8	M12	172
	17	G 3	124	134	50	85.32 – 3.53	106.4	61.9	M16	138
	17/2	G 3-½	136	152	48	98.02 – 3.53	120.7	69.9	M16	35
18	G 4	146	162	48	110.72 – 3.53	130.2	77.8	M16	34	
SAE J 518 C Code 62	50	G ½	46	54	36	18.66 – 3.35	40.5	18.2	M8	414
	51	G ¾	55	71	35	24.99 – 3.53	50.8	23.8	M10	414
	52	G 1	65	81	42	32.92 – 3.53	57.2	27.8	M12	414
	53a	G 1-¼	78	95	45	37.69 – 3.53	66.6	31.8	M14	414
	54	G 1-½	94	112	112	47.22 – 3.53	79.3	36.5	M16	414
	55	G 2	114	134	65	56.75 – 3.53	96.8	44.5	M20	400
	56	G 2-½	152	180	80	69.45 – 3.53	123.8	58.8	M24	400

Multi-flow pumps, pump combinations, pump combinations in order of type and size

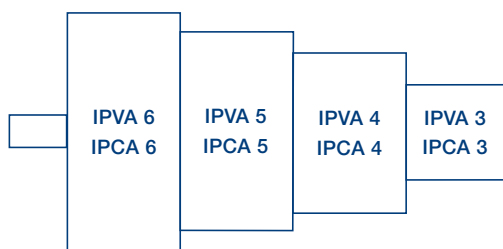

Selection

1. Determine pressure ranges and define the appropriate pump serie(s).
2. Determine pump volume and select the appropriate size
3. Define sequence of the pumps.
4. Check the torques.

Pump combinations

- IPVA,IPVA pumps of identical or different sizes can be combined in multiflow pumps.
- All sizes of the relevant pump volume are available as two- or three-flow pumps; four-flow pumps must be designed by Voith.
- The pumps are arranged in increasing order according to frame size and delivery.

Mounting, assembly

- Multi-flow pumps are generally mounted to the drive by means of a flange.

Designs

Rotation and suction

clockwise (cw)



1



1

Special design

4

Mounting flange



0 SAE-2-hole-flange

7 SAE-2-hole-flange (variant)

Shaft end



1

Type code

IPCA 3-3.5 1 0 1

Shaft end

1 Parallel shaft with keyway

Mounting flange

0 SAE-2-hole

7 SAE-2-Loch, Variante

Rotation, suction port

7 SAE-2-hole, variant

Delivery

Size	Delivery				
3	3.5	5	6.3	8	10
4	13	16	20	25	32
5	40	50	64		

Size

Type

This is a translated document
Original language: German.
Legally binding language version of the document: German.

Voith Group
St. Poeltener Str. 43
89522 Heidenheim
Germany

www.voith.com/hydraulic-systems

Contact:
Phone +49 7152 992 3
sales-rut@voith.com



VOITH

Inspiring Technology
for Generations